





Analysis of energy poverty in Andean rural households and design of an efficient cooking solution using biomass

Wladimir A Silva-Castelo ¹, Rafael Córdova-Uvidia ^{1*}, Ángel Ordoñez-Echeverría ¹,
Miguel Aquino-Arroba ²

¹ Escuela Superior Politécnica de Chimborazo, Grupo de Investigación y Desarrollo para el Ambiente y Cambio Climático, Riobamba, Ecuador; alesilvacas@gmail.com, angel.ordonez@esPOCH.edu.ec,

² Escuela Superior Politécnica de Chimborazo, Facultad de Mecánica, Riobamba, Ecuador; so-crates.aquino@esPOCH.edu.ec,

* Correspondence: rafael.cordova@esPOCH.edu.ec Phone: +593987552520

Available from. <http://dx.doi.org/10.21931/RB/2024.09.01.2>

ABSTRACT

This work explores energy poverty in the rural households surrounding the Chimborazo Faunal Production Reserve (RPFCH) and proposes an efficient cooking solution using firewood. Energy poverty was evaluated through the multidimensional poverty index (MEPI), including the 10% rule, hidden energy poverty, disproportionate expenses, and a subjective analysis of housing conditions. The research found ten households experiencing moderate energy poverty with a MEPI of 0,1562. An efficient cooking solution was proposed as an improved rocket stove design with an ignition system and forced air at the combustion chamber inlet. This stove utilizes a solar panel and batteries to power the fan. Its thermal efficiency is 13%, including Peltier cells to convert residual heat into DC electricity. The rocket stove's heating capacity is 1,6 kW, which is sufficient for heating a small room and cooking meals. After implementation, a follow-up energy poverty analysis using the same indicators is recommended to evaluate the effectiveness of the proposed solution and its impact on reducing energy poverty.

Keywords: energy poverty; rocket stove; thermal efficiency; room heating; Peltier cell; photovoltaic energy.

INTRODUCTION

Globally, approximately 800 million people lack electricity, and nearly 2,6 billion do not have access to clean cooking fuels, according to the United Nations¹. Energy poverty is the lack of or limited access to modern technologies for cooking, food refrigeration, water heating, home conditioning, and human group entertainment². The concept and measurement of energy poverty vary based on each country's reality, as in the European Union, where an estimated 35 to 100 million Europeans are afflicted by energy poverty³.

Energy poverty is significant in developing countries because it helps quantify inequity in energy access and the expenditure residents incur relative to their incomes. The number of studies related to energy poverty in developing countries has increased in the past year due to the interest shown by international organizations like the United Nations (UN), the International Energy Agency (IEA), and the Economic Commission for Latin America and the Caribbean (CEPAL)⁴.

Latin America features a varied geography with several isolated populations living in remote rural areas, far from roads and major cities, leading to limited access to energy and technological services⁵. In Ecuador, 0,76%

of the population is without access to electricity, a statistic predominantly seen in rural areas. In addition to electricity, there is a scant supply of liquefied petroleum gas (LPG) due to challenging access and road conditions in the region^{5,6}. There is only one macro-level study on energy poverty in Ecuador. The study reveals that rural regions experience greater energy poverty than urban areas⁷.

The calculation of Energy Poverty (PE) must be adjusted to the reality of the region being studied, considering the data available in the study area and analyzing some indicators using the Multidimensional Energy Poverty Index (MEPI)^{8,9} methodology. The most used indices worldwide are the Ten Percent Rule (TPR), Twice National Median Indicator (2M), Minimum Income Standard (MIS), Low Income, High Cost (LIHC), After Fuel Cost Poverty Indicator (AFCP), Hidden Energy Poverty (HEP), and the European Union Statistics on Income and Living Conditions (EU-SILC)^{4, 10 11}. Energy poverty can also be analyzed from two perspectives: i) the difficulty in connecting to or sourcing energy and ii) the lack of energy use for three main reasons - adopting new electrical devices to improve productivity, energy prices, and electricity availability¹².

Around the world, there are 2,7 billion people who depend on biomass, such as firewood, coal, or crop residues, for cooking. In rural areas of developing countries, there is a 90% biomass consumption rate¹³. The use of biomass in food cooking results in 1,6 million people dying each year due to emissions from burning fuels¹. In Latin America, 54 million people lack a clean cooking system, all primarily dependent on biomass⁵; in Ecuador, firewood consumption in 2016 was 1486 barrels of oil equivalent (BOE)⁷.

Improvements in cooking have allowed household tasks to be faster and less polluting, increasing time for other developmental activities and reducing illnesses from pollution. For instance, in Brazil, the likelihood of girls and teenagers completing primary education before turning 18 rose to 59% in 2014. A 2013 study in South Africa found that a woman's probability of finding work increased by 9%, and in Nicaragua, it increased by 23% when the time dedicated to cooking-related household activities was reduced¹⁴. In 2012, based on data obtained from deaths due to indoor pollution, more than 60% of women and children were exposed to gases produced by cooking with firewood¹⁵.

To quantify energy poverty in the community of Rio Colorado, located in the Faunal Production Reserve (RPFCH), the Multidimensional Energy Poverty Index (MEPI) method was used with four indicators: TPR, HEP, 2M, and a subjective indicator assessing if the house has leaks in the roof, walls, floors, damp foundations, or rotting window frames. After analyzing energy poverty, an efficient cooking solution is proposed using Quality Function Deployment (QFD). This method is based on designing services or products based on the customer's voice, which is translated into technical specifications with the engineer's voice, aiming to reduce energy poverty indicators and diseases caused by pollutants generated from biomass combustion¹⁶.

Nomenclature	
<i>Abbreviations</i>	
\dot{m}_{comb} , Combustion mass flow [kg/s]	ν , kinematic viscosity of the fluid
\dot{V}_{comb} , Combustion volume as a function of time [m ³ /s]	Pr , Prandtl number
$\dot{\rho}_{comb}$, Fuel density [kg/s]	Nu , Nusselt number
\dot{m}_{air} , Air mass flow [kg/s]	h , air convection coefficient [W/m ² K]
m_{comb_c} , Fuel mass flow (actual 90%) [kg/s]	L_c , characteristic length of the analyzed surface [m]
AC, Ratio of air mass to fuel mass	k , thermal conductivity. [W/mK]
\dot{Q} , heat transfer ratio [W]	ϵ , the emissivity of steel
T_f , temperature of the cold side of the cell	σ , Stefan–Boltzmann constant
T_∞ , room temperature	T_s , surface temperature
R_t , thermal resistance	P_s , the combined power of solar panels [W]
Ra: Rayleigh number	C , total daily system consumption in watt-hours [Wh]
g , gravity	ϵ , system efficiency, usually 70%
β , coefficient of volumetric expansion	B , solar battery capacity [A-h]
T_{ep} , external wall temperature	DOD , depth of discharge (50%)
T_∞ , ambient temperature	T_c , rated current of the charge controller [A]
L_c , characteristic length of the analyzed surface	V_s , voltage of the photovoltaic system [V]
	F_s , safety factor (1,3)
	ω , angular velocity [rad/s]
	V_∞ , linear fan speed [m/s]

MATERIALS AND METHODS

Energy poverty analysis

For the analysis of energy poverty, it was considered that the concept and measurement vary according to the reality of each country. The Multidimensional Energy Poverty Index (MEPI) methodology was applied. First, the Research and Development Group for the Environment and Climate Change (GIDAC) conducted a study of all the indicators and their weighting. The selection and weighting of the indicators were based on the available data and the region's reality.

Study Area

With the programs ArcGIS, Geoportal and Google Maps, the points to be analyzed in the community of Rio Colorado were delimited; a broader panorama of the area was also observed. All points are shown in Figure 1, and the coordinates of the points can be found in Google Maps through the following link: <https://goo.gl/maps/cPf5VYEMLA8p11LcA>.



Figure 1. Geographical location of households visited.

Selection and evaluation of indicators

The steps outlined in Figure 2 were followed to select the most appropriate indicator. The analysis and evaluation of the indicators, as well as their weightings, are important¹⁰. Defining the concept and impact of energy poverty in the area under study is necessary. All those involved should be knowledgeable about the most widely used indicators globally and their advantages and disadvantages.

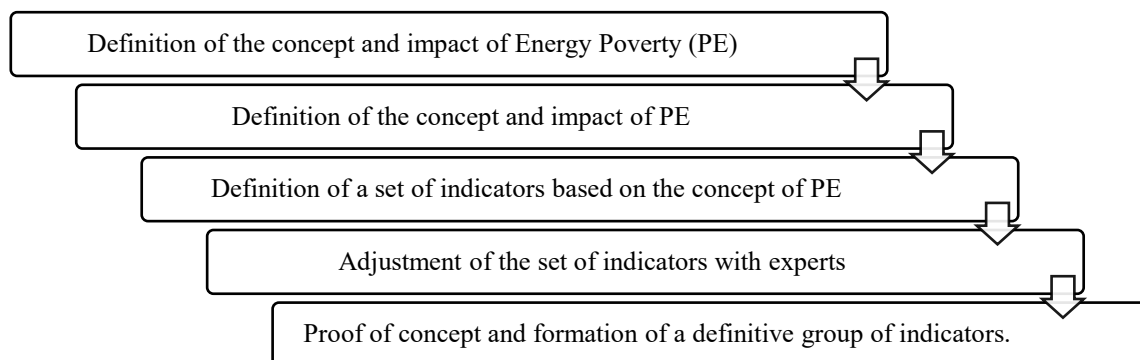

Figure 2. Indicator selection process

When defining the indicators, we selected which ones to use by analyzing data availability and ease of calculation. The following indicators were chosen: 10% Income, Hidden Energy Poverty (HEP), Disproportionate Expenditure (2M), and a subjective indicator analyzing if the house has leaks in the roof, walls, floors, damp foundations, or rotting window frames. To adjust the indicators, we transformed the kg of firewood (4,5 kWh/kg) and liquefied petroleum gas (12,80 kWh/kg)¹⁷. Finally, surveys were conducted in the community through participatory dialogue.

Using the STAMP principles of Bellagio, a system for evaluating a set of indicators was developed, in which four criteria were analyzed: Objectivity, Transparency, Practicality/Flexibility, and Participation. Several sub-criteria were generated from these criteria, which are detailed in Table 1¹⁰.

Criterion	Sub-criterion	Qualification
Objectivity	Indicators reflecting the economic dimensions of the problem are included	X
	Indicators reflecting the social dimensions of the problem are involved.	
	Indicators reflecting the environmental dimensions of the problem are involved.	
Transparency	The methodology for the selection of indicators is presented	X
	Links to data sources are indicated.	X
	Data sources are publicly available.	
Practicality and flexibility	The system for calculating indicators is quite simple.	X
	The set of indicators can be easily adapted to other research	X
	The methodology is presented (or links are shown)	X
Participation	Stakeholders or experts are involved in the indicator selection process.	X
	Stakeholders or experts are involved in determining the weights of the indicators.	X
	Scientific methods are used for the participation of stakeholders or experts (selection, agreement of opinions)	X
TOTAL		9/12

Table 1. Assessment of the set of indicators

Analysis of the cooking method

The technical visits and the analysis of energy poverty in the Rio Colorado Community allowed us to demonstrate the cooking methods and the use of firewood, as shown in Figure 3. Once the cooking problem in the community was identified, the user's voice was obtained through participatory dialogue.



Figure 3. Food cooking method in the Rio Colorado community.

The user's voice allowed the engineer's voice to be obtained and these values to be quantified into accurate data. Additionally, the parameters for increasing the combustion efficiency of wood stoves, lowering their emissions and improving their safety were utilized.¹⁸

Functional analysis

Figure 4 describes the functions of the efficient cooking solution, starting from level 0 and extending to all parts of the design. Level 0, at this level, what the efficient cooking method does is described, where firewood and air enter, and heat energy for cooking and home heating is produced; power is also generated through a Peltier cell.

Level 1, at this level, the definition of modules emerges, where the first module is the heat energy generated by the stove, and the second module is the electrical energy and the forced air directed to the combustion chamber. Module 1: Combustion chamber, heat energy, gases, ashes, ashtray. Module 2: DC Electricity, battery, fan, external power source.

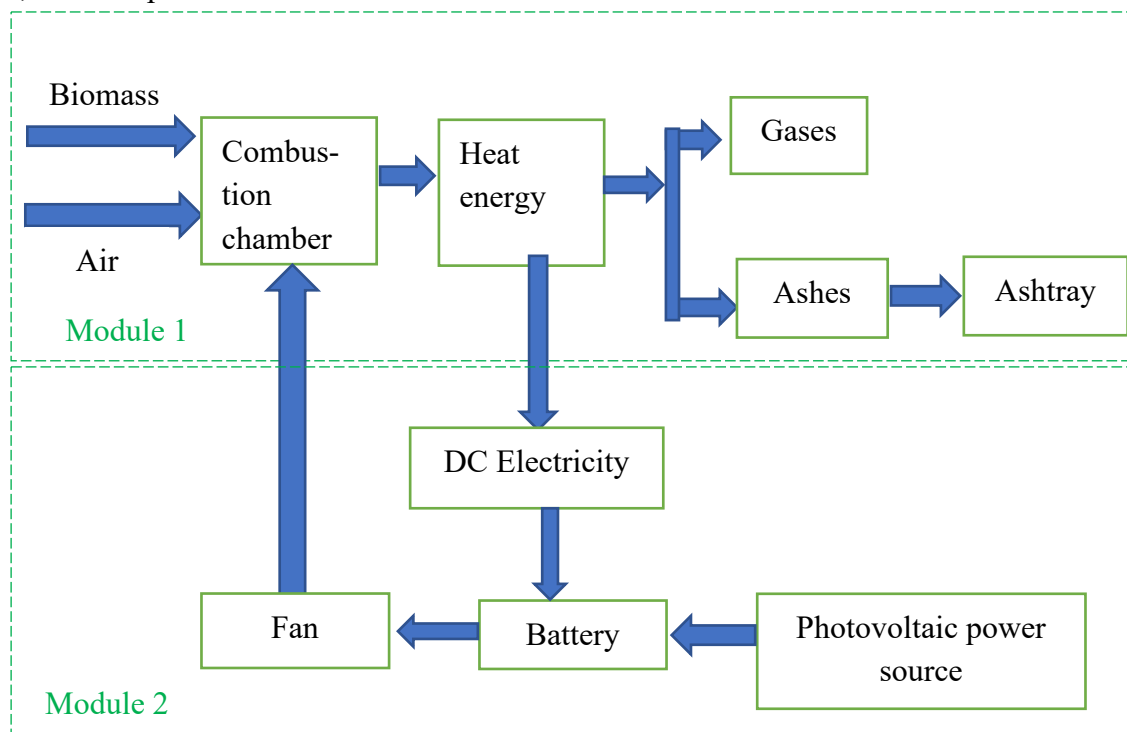

Figure 4. Niveles de análisis funcional

Analysis of Solutions

An analysis was made in Clean Burning Biomass Cook-stoves 2nd Edition 2021, where the main characteristics that a wood stove should have, such as air intake, consumption, and efficiency, were obtained¹⁹. To corroborate the stove's characteristics, the Quality Function Deployment (QFD) Annex1 and the stove's modules were used. The main factors were obtained: wood input, grate, energy source, and air input. With the help of CAD software (SolidWorks), different solutions were produced, and then the advantages and disadvantages of each solution were analyzed.

Figure 5 shows three options based on the Quality Function Deployment Matrix for the required cooking solution. Figure 5 (a) features a mechanical air controller; air enters below the wood, but the disadvantage is that the user must push the wood. In Figure 5 (b), there's no need to make the wood (entrance at 45°); the air enters the combustion chamber downwards using a fan; its main disadvantages are a single energy source (Peltier cell) and the vertical grate that may prevent ash from descending optimally. Finally, Figure 6 (c) has forced air input, double combustion chamber, dual-energy source, and interchangeable grate; however, it has the disadvantage that if there is no sun or the stove is not used with this method, the battery could be discharged.

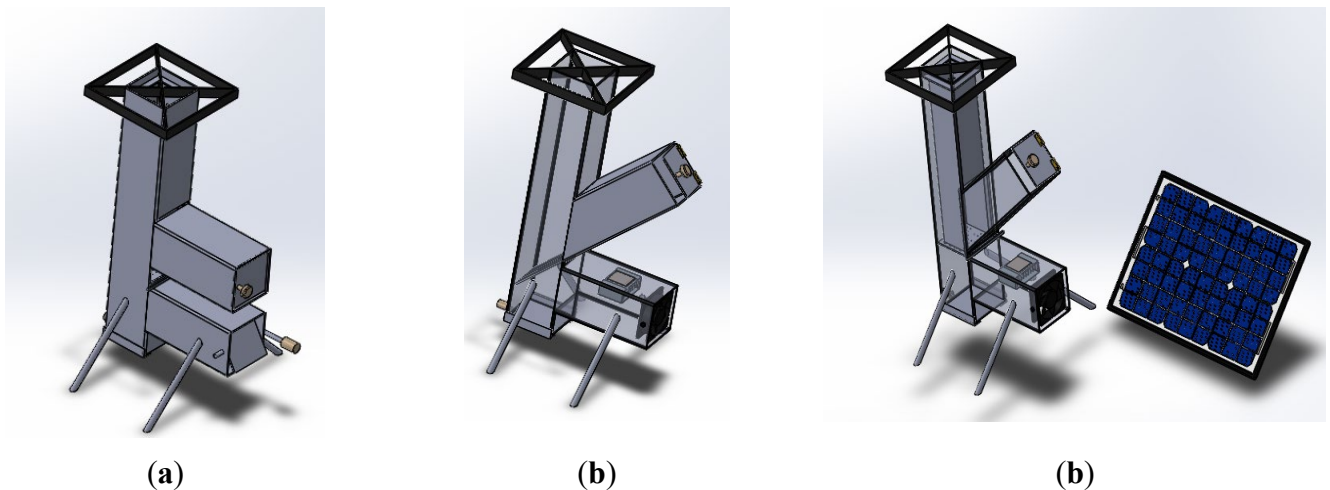

Figure 5. Possible solutions are (a) natural convection rocket stove, (b) forced convection rocket stove, and (c) forced convection rocket stove powered by a solar panel.

The solution is evaluated using the weighted criteria method. For the application of this method, a value of 1 is utilized to assign higher relevance, 0,5 for equal significance, and 0 when there is less relevance to the criterion being compared.

Low cost: This is important as it is aimed at individuals with scarce economic resources. **High efficiency:** This will allow the user to cook faster and more efficiently. **Low emissions:** Emissions need to be quiet because the woodstoves are used in indoor home areas. **Energy source:** The energy source is crucial, especially in remote areas with no constant network. **Minimal maintenance:** Maintenance should be as simple as possible, or in its absence, the user should be able to carry it out independently.

With these parameters, each criterion's specific weight was evaluated, where low emissions, high efficiency, low cost, energy source, and minimal maintenance were also analyzed. As a result, Figure 5 (c) was identified as the ideal solution.

Key features of simulation

In the Computational Fluid Dynamics (CFD) analysis, the control volume is isolated, considering the inflow and outflow of combustion gases in 2D. To analyze the mass flow of firewood, equation (1) was used with a combustion volume flow rate. \dot{V}_{comb} of $0,0375 \text{ m}^3/\text{h}$ and a ρ_{comb} of $780 \text{ m}^3/\text{kg}$. The volumetric flow and density values are experimental data obtained from wood in the Sinincay community of Cuenca ²⁰.

$$\dot{m}_{comb} = \dot{V}_{comb} \times \rho_{comb} \tag{1}$$

A value of \dot{m}_{comb} of 0,9965 kg/s, the AC value was calculated using a humidity of 20% and a combustion efficiency 0,8. These values were entered into equation (2), and the mass air flow was calculated (\dot{m}_{aire})

$$\dot{m}_{air} = \dot{m}_{comb_c} \times AC \tag{2}$$

The geometry of the rocket stove was calculated using the Ansys software. The fuels' and air's mass flow are used for combustion in the software. Once these data were obtained, the temperature at the pot's base was determined, which should be greater than or equal to 62,85 °C ²¹.

A 2D model was created in the Ansys software, using the dimensions shown in Figure 6 (a), to determine the distance at which this temperature is achieved. The geometry values were entered in the Details View section, as shown in Figure 6 (b). The geometry values are based on the general measurements of the rocket stove.

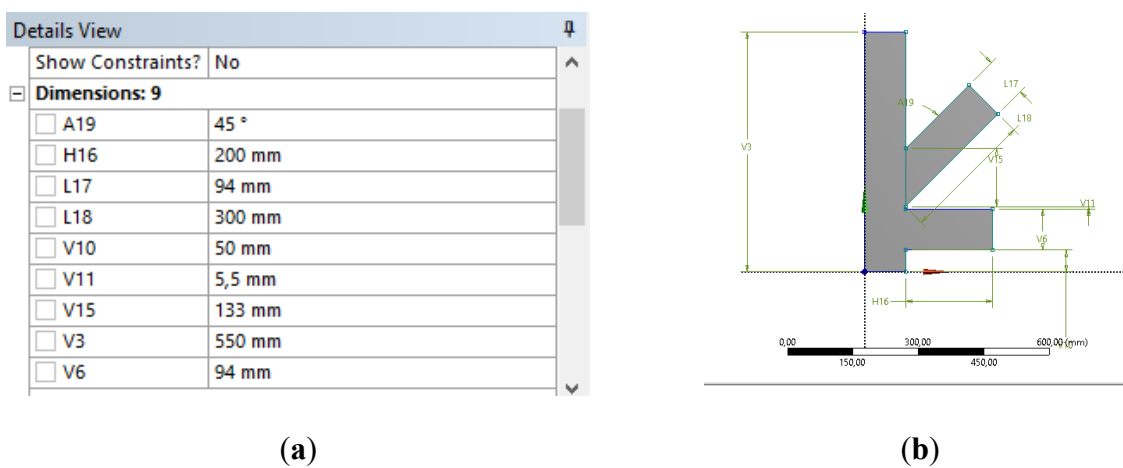

Figure 6. Parameterization of the geometry (a) dimensions entered the program (b) model 2 D analyzed.

The geometry was meshed with a size of 5 mm, and the Fluent CFD was chosen as the reference physics to ensure the meshing matches the simulation requirements. In Figure 7 (a), you can observe the meshing in Ansys, and Figure 7 (b) demonstrates that it meets the minimum meshing requirements. The average value is 0,98079, and the image reveals that most elements have a regular shape, validating the mesh quality.

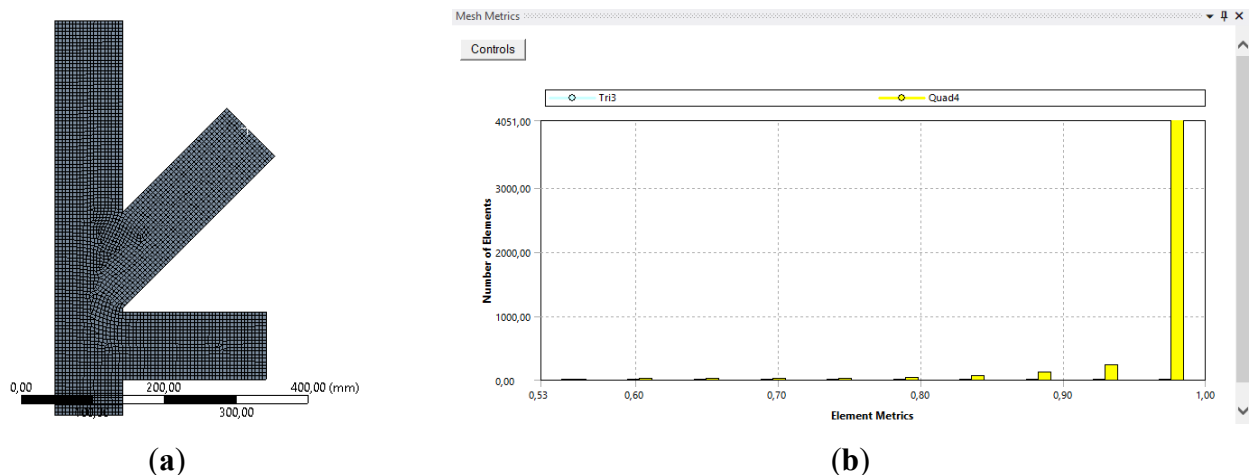

Figure 7. Meshing in Ansys (a) 2D meshing (b) mesh quality

Thermo-Structural Analysis of the Woodstove

In Figure 8 (a), the geometry for the thermo-structural analysis is shown. Some parts that do not affect the structure's resilience were removed. The surface where the temperatures reached during combustion were applied is detailed in Figure 8 (b).

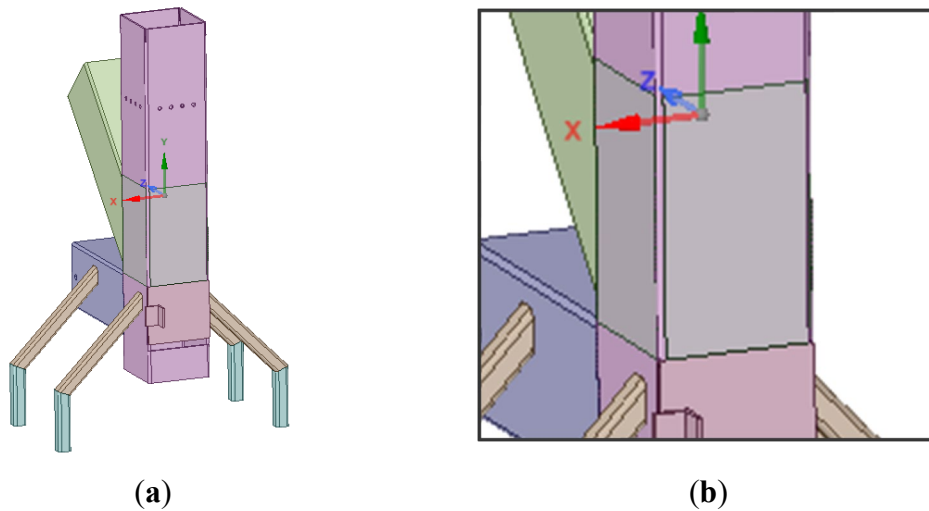

Figure 8. (a) 3D geometry for structural thermal analysis, (b) Thermal limit in the combustion chamber.

The average temperature was obtained in each wall using an infrared thermometer, as shown in Figure 9. A mesh was painted on the walls of the rocket stove, and the points were mapped when the stove reached thermal equilibrium; the average measured temperature was 397 °C.



Figure 9. Measurement of temperatures in the three walls of the combustion chamber

The mechanical method was chosen for the physical mesh analysis, and a mesh size of 7 mm was applied to the entire geometry. To improve the combustion, extra holes were added to promote double combustion. Ansys' inflation command achieved a more optimal and high-quality mesh. The static thermal analysis is performed by communicating two solutions, Steady-State Thermal and Static Structural, where the data are shared for the final analysis. The weight of the pot with water was 5 kg, obtained using a digital scale, as shown in Figure 10.



Figure 10. Weight for structural thermal analysis

Heating power of the wood-burning stove

A significant feature of a wood-burning stove in rural areas of Chimborazo is that, in addition to cooking, it can heat the surrounding environment. To determine whether the wood-burning cooking method heats a room, the calorific power of the stove's walls is calculated, which was obtained using equation (3).

$$\dot{Q}_{wall} = 4(\dot{Q}_{p\ convection}) + 4(\dot{Q}_{p\ radiation}) \quad (3)$$

For the calculation of the film temperature in equation (4), the values $T_{ep}=377,225^{\circ}\text{C}$ and an ambient temperature $T_{\infty}=3^{\circ}\text{C}$ were applied.

$$T_p = \frac{T_{ep} + T_{\infty}}{2} \quad (4)$$

With equations (5) to (9) dimensionless numbers $R_a = 319990487,1$, $Nu = 86,472$, and the coefficients $h = 8,0874 \frac{\text{W}}{\text{m}^2\text{k}}$ $Q_{convection} = 15,758 \text{ W}$ $\dot{Q}_{radiation} = 398,310 \text{ W}$, were obtained. The last 2 values were replaced in Equation 3, getting a value of $\dot{Q}_{walls} = 1,656 \text{ kW}$, this value is more excellent than 1 kW, which means that the proposed woodstove would be able to heat a small room.

$$R_a = \frac{g \times \beta (T_{ep} + T_{\infty}) \times Lc^3}{\nu^2} \times Pr \quad (5)$$

$$Nu = \left\{ 0,825 + \frac{0,387(R_a)^{\frac{1}{6}}}{\left[1 + \left[\frac{0,492}{Pr} \right]^{\frac{9}{16}} \right]^{\frac{8}{27}}} \right\}^2 \quad (6)$$

$$h = \frac{Nu \times k}{Lc} \quad (7)$$

$$Q_{convection} = h(A_s)(T_s - T_{\infty}) \quad (8)$$

$$\dot{Q}_{radiation} = \varepsilon \times \sigma \times A_s \times (T_s^4 - T_{around}^4) \quad (9)$$

Analysis of the photovoltaic system

To determine the electric loads, the fan was analyzed with a voltage of 12 V and an amperage of 0,14 A; both values need to be entered into equation (10) to obtain the power that is required in the system. after doing the calculations, this value totals 1,68 W.

$$Pow = VI \quad (10)$$

Having obtained the power, we analyzed the time of its use. Generally, and according to the data collected in the community, the cooking time is four hours a day. With this data and the power, we applied equation (11) where we obtained $Energy\ consumed = 5,04\ Wh/d$ ²²

$$Energy\ consumed = Pow(cooking\ time) \quad (11)$$

The province of Tungurahua in Ecuador has an average irradiation of 5,4 kWh/m², equivalent to 5,4 solar hours. This middle irradiation determined the solar panel's necessary power for our air intake system ².

For the charge controller, an LM7805 voltage regular was used that admits up to 1 A, thus validating the value of the nominal current of 0,33 A, with a 1N4007 diode that prevents the return of the energy of the 3,7 V battery; it also has an MT3608 voltage elevator that is regulated to 12 V at the voltage output. The control of the energy input to the circuit is done with an LED spotlight to the entrance with a resistance of 100 ohms. The system can be seen in Figure 11.

The airflow controller circuit is shown in Figure 12; it was constructed using a TIP 122 transistor, a 10k potentiometer for the transistor base and a 100uF capacitor for the motor. The solar panel can power the circuit or, if there is no sun, by a 12V transformer connected to a battery.

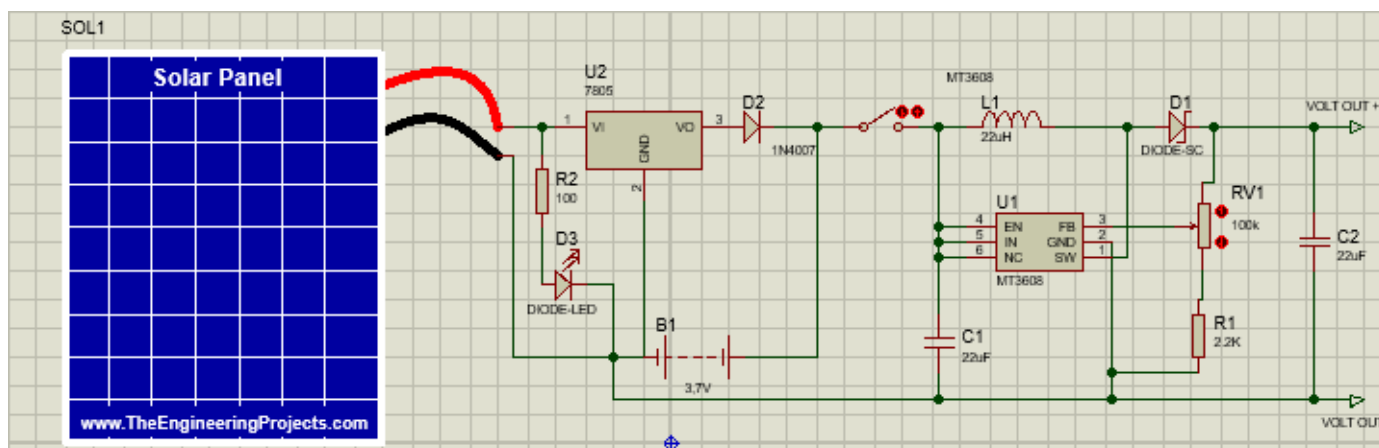

Figure 11. Charge controller circuit

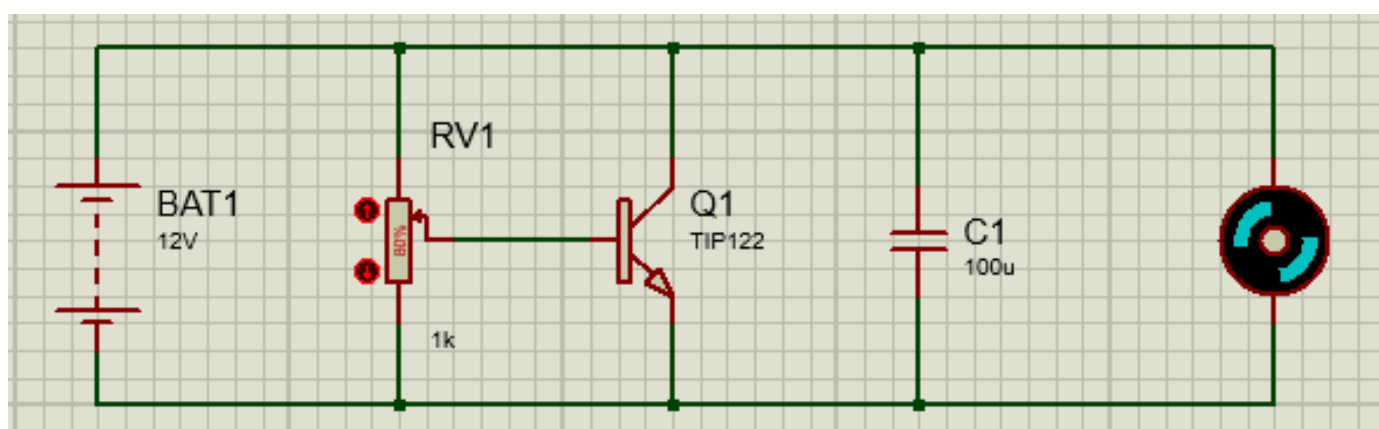

Figure 12. Speed regulator circuit

Calculation of the Peltier cell heatsink.

The community in the Andean area of Ecuador may not have sunlight on some days of the week; therefore, the possibility of installing Peltier cells, which give energy on cloudy days, was analyzed. The Peltier cell examined is TEC1-12705, which works at a maximum temperature of 138 °C.

Figure 16 (a) shows the temperature at the air inlet. The temperature in the selected face of the stove was approximately 75,57 °C. The fan speed was taken as 6,28 m/s, around 6 m/s. The area's ambient temperature is 10 °C in the day and 3 °C at night, giving an average of 6,5 °C²³.

Three Peltier cells generated a potential difference of 2.5V, so the LM7805 regulator regulates the voltage and powers the 3.5V battery. The fin and fin-free areas were determined; these measurements are shown in Figure 13; the heatsink length is 50 mm with these data areas. $A_{alet} = 0,0108 m^2$ y un $A_{alet} = 2,8x10^{-3}m^2$ respectively were calculated.

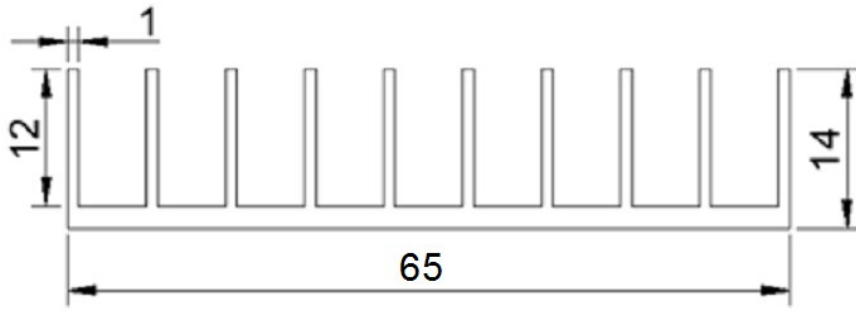

Figure 13. Heat sink

RESULTS

Finally, table 2 shows the results of the energy poverty of all the houses in the community of Rio Colorado were obtained. With the help of Excel, each of the results was weighted. All houses suffer from energy poverty because they all have a value greater than 0,25.

Number of households		C1	C2	C3	C4	C5	C6	C7	C8	C9	C10	Equivalence
k=4	Indicators											
1	10%	0	0	0	1	1	0	1	1	1	0	0,25
2	HEP	0	0	0	0	0	0	0	0	0	0	0,25
3	2M	1	1	1	1	1	1	1	1	1	1	0,25
4	Housing condition	1	1	1	1	1	1	1	1	1	1	0,25
	Energy poverty condition	0,50	0,50	0,50	0,75	0,75	0,50	0,75	0,75	0,75	0,50	
	Energy-poor house	YES	YES	YES	YES	YES	YES	YES	YES	YES	YES	

Table 2. Study of energy poverty in the production reserve of Fauna Chimborazo community Río Colorado (Tungurahua)

Figure 14 shows the four indicators that measure energy poverty. It is observed that the HEP meter does not exist in any of the houses analyzed, and Table 3 shows an MEPI of 0,1562, which is moderate energy poverty.

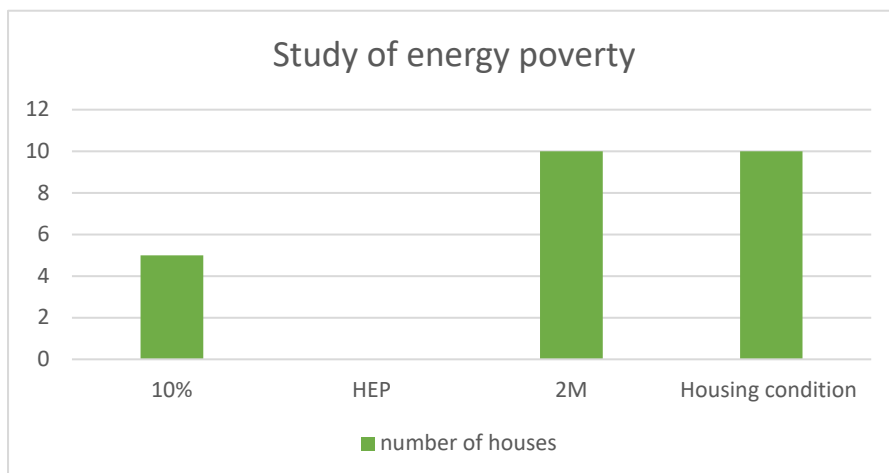

Figure 14. Indicators to measure energy poverty.

Total number of households (n)	10		
Households with energy poverty (q)	10		
Total number of indicators (k)	4		
EPIR incidence rate (q/n)	1		
Numerator	C	q	c*q
	0,50	5	2,5
	0,75	5	3,75
	1	0	0
Total, numerator	6,25		
Total, denominator	40		
IEP Intensity	0,15625		
MEPI	0,15625		

Table 3. Energy poverty results and MEPI indicator

Validation of the geometry of the cooking solution.

If the combustion simulation is turbulent, this distance must be reduced. Figure 14 (a) shows a laminar flow that validates the distance from the combustion chamber²⁴. The rocket stove can be built and assembled with Ansys analysis verifying the temperature and flow velocity. Finally, the contaminants generated in the combustion were simulated; in Figure 15 (b), the mass fraction of CO₂ with the efficient cooking method (rocket cooker) is observed, with a value of 0,2164.

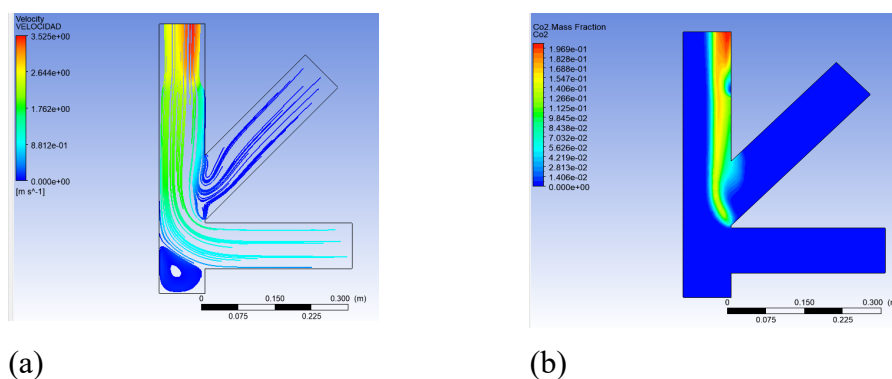

Figure 15. Ansys Simulation (a) Velocity (b) CO₂ mass fraction

Static thermal simulation

Figure 15 (a) shows the temperature range reached by the kitchen throughout its structure, having a maximum of 344 °C and a temperature of 75 °C. Figure 16 (b) is the deformation analysis, with a maximum of 1,6856mm at the top and 0,38 at the legs of the rocket stove. The von Mises effort has a maximum value of 690 MPa in the small effort concentrators found in the corners of the rocket kitchen, as shown in Figure 15 (c).

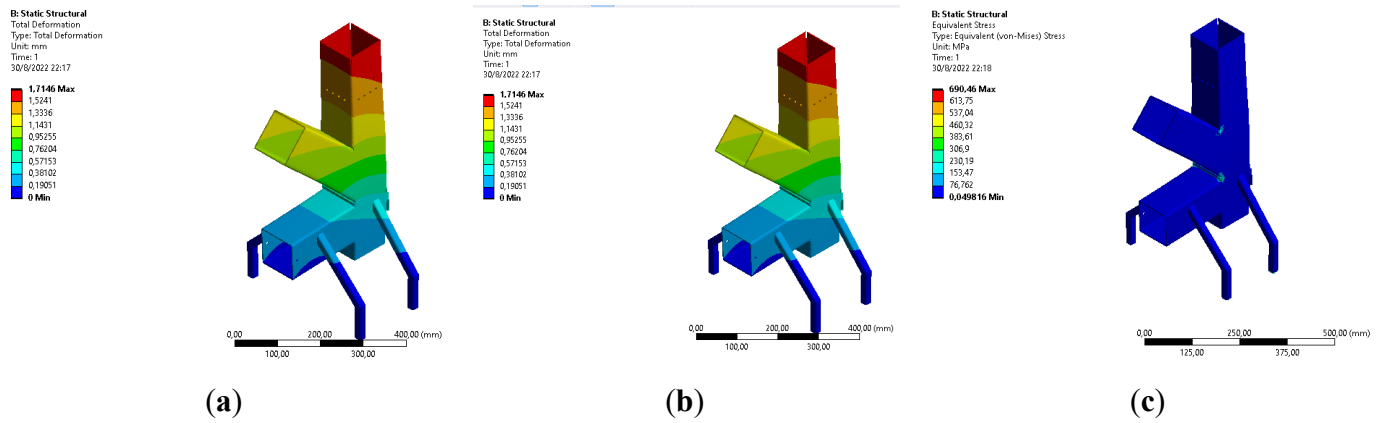

Figure 16. Analysis in Ansys (a) temperature (b) strain (c) Von Mises stress

Heat sink simulation and thermoelectric generation

Figure 16 (a) shows the temperature variation in the Peltier cell; at the bottom, a temperature of 75 ° C was placed, and with the wind speed generated from the fan we have a temperature of 38,49 ° C. Figure 17 (b) shows the thermoelectric power generation of the Peltier cell, having a maximum of 2 V of generation. Therefore, three cells of the same characteristics were coupled to generate the 6 V of potential.

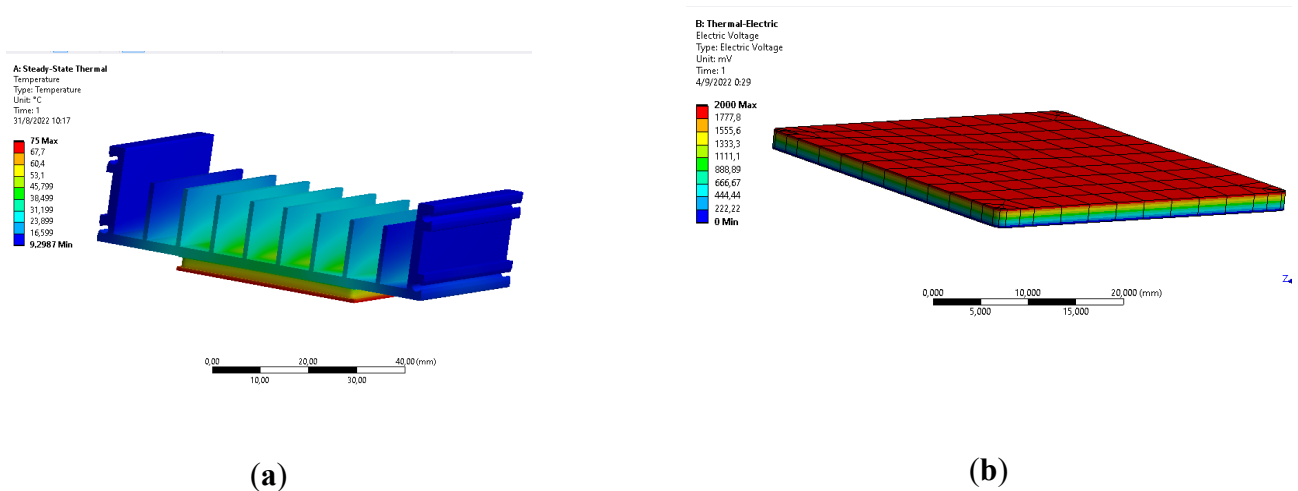

Figure 17. Simulation (a) heat dissipation (b)

Rocket stove efficiency with the WBT method

Table 4 shows the value of thermal efficiency; in this case, we have a value of 13%, which, compared to traditional methods (7%), dramatically exceeds thermal efficiency²⁵. The WBT test has 3 phases: cold start, hot start, and medium fire phase; however, a quick test can be performed. The rapid test consists of analyzing the stove only with a cold start and simmering if said stove has little mass²⁶.

Calculation/Results	Units	data	label
Fuel consumed (moist)	g	1,250	f_{cm}
Net change in char during the test	g	(10)	ΔC_c
Equivalent dry fuel consumed	g	981	f_{cd}
Water vaporized from all pots	g	300	w_{cv}
Effective mass of water boiled	g	4,926	w_{cr}
Time to boil Pot #1	min	85	Δt_c
Temp-corr time to boil Pot #1	min	82	Δt_c^T
Thermal efficiency	%	13%	h_c
Buring rate	g/min	11,5	r_{cb}
Specific fuel consumption	g/liter boiled	199	SC_c
Temp-corr sp consumption	g/liter	191,5602547	SC_c^T
Temp-corr sp energy consumption	kJ/liter	3,609	SE_c^T
Firepower	watts	3625	FP_c

Table 4. Calculation of thermal efficiency using WBT

DISCUSSION

Energy poverty in homes in the community of Rio Colorado in the province of Tungurahua, belonging to the RPFCC, was analyzed using an MEPI, and a rocket woodstove was designed, which can potentially improve the community's quality of life. Based on the bibliographic study with PSALSAR methodology, PICOC, the most used indicators and methods for the analysis of energy poverty at the macro, meso and micro levels worldwide were found, as well as the methods of measuring energy poverty in developing countries that are applicable in rural communities of Ecuador.

The analysis of energy poverty in the Rio Colorado community revealed that all 10 households studied are experiencing energy poverty. This issue contributes significantly to the community's economic and social challenges. Each household's energy poverty status was determined through a multi-indicator method using four indicators: 10% rule, Housing Energy Poverty (HEP), Two Times Median (2M), and housing conditions. It should be noted that energy poverty is influenced by various factors such as income, energy prices, and the house's energy efficiency.

This evaluation resulted in an energy poverty index incidence rate of 1 and a moderate energy poverty intensity index (MEPI) of 0,1562. Although this intensity level is mild, it emphasizes the pressing need to address the energy poverty situation in this community, enhance the living conditions, and stimulate the potential for economic development. Unlike the index (MEPI) for all of Ecuador, which was 0,013 in 2014, this index has a percentage of 47% in the Sierra region, confirming that the problem exists in Ecuador ⁷.

Further, the CO₂ mass fraction for this efficient cooking method was found to be 0,2164, which, while not ideal, is significantly less than traditional cooking methods. Reducing CO₂ emissions is crucial in the fight against global warming, and implementing more efficient cooking methods like this could dramatically contribute to emission reduction efforts.

The static thermal simulation shows that the temperature range throughout the rocket stove's structure was within acceptable parameters, with a maximum of 344 °C and a minimum of 75 °C. The deformation and Von-Mises stress analyses showed that the structure can withstand the heat generated during cooking, ensuring the stove is robust and safe to use.

In addition to providing a cooking solution, this study aimed to generate electricity using Peltier cells. The temperature gradient across the Peltier cell ranged from 75 °C to 38,49 °C, which produced 2 V of electrical power per cell. The maximum voltage generated by the TEC1-12708 cell is 2,33 V; therefore, the cell would be causing an optimal voltage by not reaching the maximum nor being below this value²⁷. Each household could generate 6 V of electricity using three cell-like kitchens with the same characteristics and provide valuable additional energy resources²⁸.

The final aspect of the rocket stove's performance, its thermal efficiency, was measured using the Water Boiling Test (WBT). Compared to traditional methods, with a thermal efficiency of around 7%, the rocket stove showed a significantly higher thermal efficiency of 13%. The thermal efficiency is superior to other wood stoves that range from 9 to 12% efficiency²⁹.

While the results from this investigation are promising, the study is limited by its small sample size. Further research should involve more households and varied geographic conditions to evaluate the solution's scalability and adaptability. Also, a cost-benefit analysis is recommended to assess the financial viability of implementing such rocket stoves on a broader scale.

CONCLUSIONS

This study demonstrates the alarming prevalence of energy poverty in the Rio Colorado community and proposes a promising and practical solution: a rocket wood stove. This solution could potentially address the urgent need for reliable energy sources, significantly improve the living conditions of the inhabitants, and contribute towards sustainable development goals. Further research and efforts are needed to scale this solution to a broader community level.

A MEPI multidimensional energy poverty index was applied to analyze energy poverty after carrying out the indicator selection process with a panel of experts. Each indicator was weighted with a value of 0,25. A participatory dialogue guide was developed, which allowed data to be obtained through field visits to the community.

The study further investigated the implementation of a rocket wood stove as a potential solution, utilizing ANSYS Computational Fluid Dynamics (CFD) software to conduct an in-depth analysis of the fluid velocity and maximum temperatures achieved by the stove. The velocity analysis confirmed a lack of turbulence in the combustion process, leading to efficient and stable operation. Simultaneously, the temperature results, peaking at about 900°C, verified the suitable length of the stove's combustion chamber, ensuring adequate heat for cooking purposes.

Author Contributions: Conceptualization, Wladimir Silva-Castelo, Rafael Córdova-Uvidia.; methodology, Wladimir Silva-Castelo, Rafael Córdova-Uvidia, and Miguel Aquino-Arroba.; software, Wladimir Silva-Castelo, and Miguel Aquino-Arroba.; validation, Wladimir Silva-Castelo, Rafael Córdova-Uvidia.; formal analysis, Wladimir Silva-Castelo.; investigation, Wladimir Silva-Castelo, Rafael Córdova-Uvidia.; data curation, Ángel Ordoñez-Echeverría.; writing—original draft preparation, Wladimir Silva-Castelo.; writing—review and editing, Rafael Córdova-Uvidia and Miguel Aquino-Arroba.; visualization, Wladimir Silva-Castelo.; supervision, Miguel Aquino-Arroba.; project administration, Ángel Ordoñez-Echeverría.; funding acquisition, Ángel Ordoñez-Echeverría. All authors have read and agreed to the published version of the manuscript.

Funding: This research project has received funding from Escuela Superior Politécnica de Chimborazo through project grant No. IDIPI-274

Institutional Review Board Statement: This project has been approved by the resolution of the Polytechnic Council No. 353.CP.2021 and has written authorization from the Bioethics Committee led by Prof. María Viteri dated 7 June 2021.

Informed Consent Statement: Informed consent was obtained from all subjects involved in the study.

Conflicts of Interest: The authors declare no conflict of interest.

REFERENCES

1. ONU. Ending Energy Poverty Saves Lives and Saves the Planet. Available online: <https://www.un.org/es/climatechange/damilola-ogunbiyi-ending-energy-poverty> (14-02-2022).
2. Griffa, P. B. Exploring the Concept of Energy Poverty. *Cent. Invest. Econ. Plan.* **2019**, *1*, 1–4.
3. European Commission. Energy Poverty Advisory Hub Course Plataform. Available online: https://energy-poverty.ec.europa.eu/get-support/trainings-catalogue/epah-introductory-course-introduction-energy-poverty-and-epah_en (13-04-2021).
4. Sy, S. A. & Mokaddem, L. Energy Poverty in Developing Countries: A Review of the Concept and its Measurements. *Energy Res Soc Sci* 2022 *89*, 102562.
5. Calvo, R., Álamos, N., Marco, B., Anahi, U. & Rubén, C. L. Development of Energy Poverty Indicators in Latin America and the Caribbean. 2020,60.
6. Carrere, J. *et al.* Energy Poverty, its Intensity and Health in Vulnerable Populations in a Southern European city. *Gac Sanit* 2021 *35*, 438–444.
7. Quishpe, P., Taltavull, P. & Juárez, F. Energy Poverty in Ecuador. *Sustainability (Switzerland)* 2019 *11*, 1–19.
8. Nussbaumer, P., Bazilian, M. & Modi, V. Measuring Energy Poverty: Focusing on What Matters. *Renewable and Sustainable Energy Reviews* 2012 *16*, 231–243.
9. Sebastian Levine, J. M. and Y. M. B. A Robust Multidimensional Poverty Profile for Uganda. *Oxford Poverty and Human Development Initiative* 2012, 27.
10. Siksnylyte-Butkiene, I., Streimikiene, D., Lekavicius, V. & Balezentis, T. Energy Poverty Indicators: A Systematic Literature Review and Comprehensive Analysis of Integrity. *Sustain Cities Soc* 2021 *67*, 102756.
11. Santillán, O. S., Cedano, K. G. & Martínez, M. Analysis of Energy Poverty in 7 Latin American Countries Using Multidimensional Energy Poverty index. *Energies (Basel)* 2020 *13*,.
12. Ayodele, T. R., Ogunjuyigbe, A. S. O. & Opebiyi, A. A. Electrical Energy Poverty Among Micro-enterprises: Indices Estimation Approach for the City of Ibadan, Nigeria. *Sustain Cities Soc* 2018 *37*, 344–357.

13. Urmee, T. & Gyamfi, S. A Review of Improved Cook-stove Technologies and Programs. *Renewable and Sustainable Energy Reviews* 2014 33,625–635.
14. UN Enviroment. Global Gender and Environment.2016 doi:10.18356/0b979453-en.
15. WHO. Ambient Air Pollution. 2016.
16. Yacuzzi, E., Martín, F. & Pharma, A. QFD: Concepts, Applications, and New Developments. 2016, 1–37 doi:10.1007/b138775.
17. Mirza, B. & Szirmai, A. Towards a New Measurement of Energy Poverty: A Cross-Community Analysis of Rural Pakistan. *UNU-MERIT Working Paper Series 024* 2010 44, 1–41.
18. Baldwin & Winiarski. Design Principles for Wood-Burning Stoves by Documents Ecoaldeas - Issuu. 1987.
19. Still, D. Earthen Stove Aprovecho Class June 2002. 2002, 18–21.
20. García, G. & Pañi, L. Optimization of the Energy Efficiency of Firewood (Eucalyptus Globulus) as fuel in an Artisanal Brick Kiln Model, Through the Analysis and Modification of Fuel Characteristics, Third Level, Salesian Polytechnic University, Ecuador, 2013, 195.
21. Kshirsagar, M. P. & Kalamkar, V. R. User-Centric Approach for the Design and Sizing of Natural Convection Biomass Cook-stoves for Lower Emissions. *Energy* 2016 115, 1202–1215.
22. Vaca, D. & Ordóñez, F. Research in Alternative Energy. 2019, 12–26.
23. The Weather Channel. Weather Map and Radar. Available online: <https://weather.com/es-GT/tiempo/mapas/interactiva/1/d0402d7fffa1e3a93baa0a4002cee53c88a61a4db957474bec102e62374a0706> (12-03-2021).
24. Gandigude, A. & Nagarhalli, M. Simulation of Rocket Cook-Stove Geometrical Aspect for its Performance Improvement. *Mater Today Proc* 2018 5, 3903–3908.
25. Recalde, C. *et al.* In-situ Energy and Security Evaluations of Wood Stoves in the High Andean Region of Ecuador. *Espacios* 2018 39.
26. Global Alliance For Clean Cook-stoves. Water boiling test (4.2.3). 2014.
27. Nuwayhid, R. Y., Rowe, D. M. & Min, G. Low-Cost Stove-Top Thermoelectric Generator for Regions with Unreliable Electricity Supply. *Renewable Energy* Available online: www.elsevier.com/locate/renene (13-08-2022) vol. 28.
28. Champier, D. *et al.* Study of a TE (thermoelectric) Generator Incorporated in a Multifunction Wood Stove. *Energy* 2011 36, 1518–1526.
29. Medina, P., Núñez, J., Ruiz-García, V. M. & Beltrán, A. Experimental and Numerical Comparison of CO₂ Mass Flow Rate Emissions, Combustion and Thermal Performance for a Biomass Plancha-Type Cookstove. *Energy for Sustainable Development* 2021 63, 153–159.

ANNEXES 1. Quality Function Deployment for efficient firewood cooking solution.

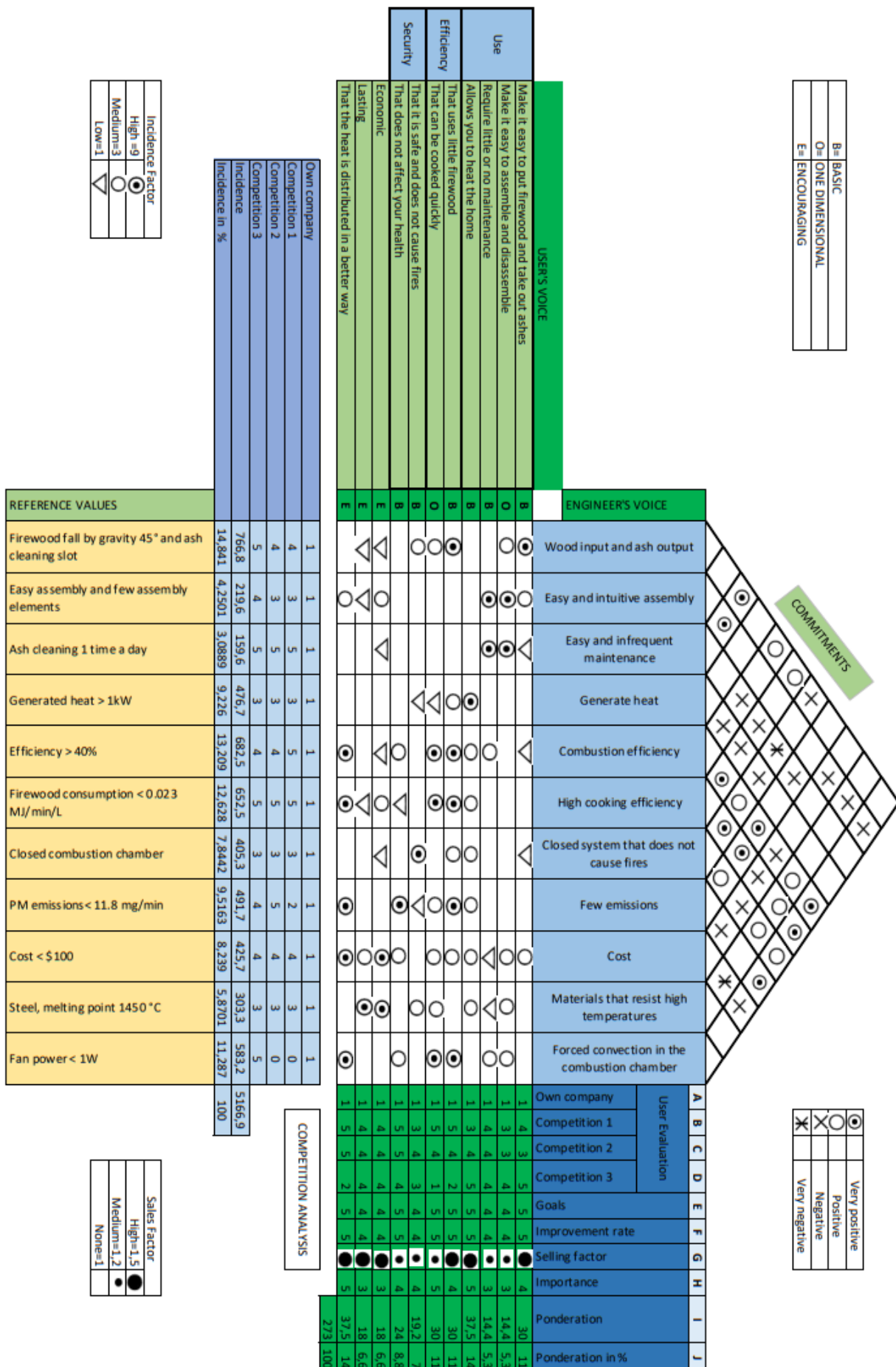

Received: 9 October 2023/ **Accepted:** 15 January 2024 / **Published:** 15 February 2024

Citation. Silva-Castelo W A, Córdova-Uvidia R, Ordoñez-Echeverría Á, Aquino-Arroba M. Analysis of energy poverty in Andean rural households and design of an efficient cooking solution using biomass. *Revis Bionatura* 2024; 9 (1) 2. <http://dx.doi.org/10.21931/RB/2024.09.01.2>

Additional information Correspondence should be addressed to rafael.cordova@epoch.edu.ec

Peer review information. Bionatura thanks anonymous reviewer(s) for their contribution to the peer review of this work using <https://reviewerlocator.webofscience.com/>

All articles published by Bionatura Journal are made freely and permanently accessible online immediately upon publication, without subscription charges or registration barriers.

Bionatura ISSN. First 13909355 Ecuador. **Scopus coverage years:** from 2016 to the Present

Publisher's Note: Bionatura stays neutral concerning jurisdictional claims in published maps and institutional affiliations.

Copyright: © 2023 by the authors. They were submitted for possible open-access publication under the terms and conditions of the Creative Commons Attribution (CC BY) license (<https://creativecommons.org/licenses/by/4.0/>).